



Product Overview

Health Screen Kiosk Monitoring Solution with AI Temperature Measurement

Temperature measuring cameras with high-precision temperatures can help detect increases in body temperature, which may indicate fever or infections by COVID-19. Temperature measuring Health Screen Kiosk monitoring solution can be used for high-temperature checks of employees, visitors, general population, shoppers and workers.

Product Recommendation

Winmate HSK-200 (Full Automation and Accurate Solution with Face Recognition)

✓ PPC

- 7"/ 10.1"/ 15" TFT LCD with PCAP touch
- Intel® Celeron® Bay Trail-M N2930, 1.83 GHz
- Fanless cooling system and ultra-low power consumption
- Supports PoE function
- All-around RGB LED Light Bar
- Optional HF RFID Reader
- Stylish design for room booking, access control and room information applications

✓ Market Ready solution software:

- StaySafe+
- Mask Detection
- Temp Screening
- Face Recognition



Winmate HSK-205(Multiple Entries)

✓ PPC

- 7"/ 10.1"/ 15" TFT LCD with PCAP touch
- Intel® Celeron® Bay Trail-M N2930, 1.83 GHz
- Fanless cooling system and ultra-low power consumption
- Supports PoE function
- All-around RGB LED Light Bar
- Optional HF RFID Reader
- Stylish design for room booking, access control and room information applications

✓ Market Ready solution software:

- StaySafe
- Mask Detection
- Temp Screening



Key features

- ✓ Built in high-precision thermal infrared module, temperature detection range - 10 °C ~ 150 °C, accuracy ± 0.3 °C
- ✓ Support OSD real-time display and superposition of human body temperature
- ✓ Supports low temperature alarm, high temperature alarm, regional temperature difference alarm and other alarm modes
- ✓ Binocular face recognition, supporting infrared live detection, large face database, which can support up to 50000
- ✓ Equipped with 10.1" TFT LCD with PCAP touch
- ✓ Good environmental adaptability, adapt to low light and strong backlight, and support automatic face exposure
- ✓ Supports Wigan protocol, can directly drive access control, and control various gates, etc

Solution Offering & Timeline

Health Screening Kiosk (HSK)

	Hardware/ Mechanical	Software (StaySafe App)
HSK-101	Kit Only (for Kiosk maker)	StaySafe Mask Detection/ Temp Screening
HSK-200	Whole Kiosk (for End user)	StaySafe Mask Detection/ Temp Screening
HSK-205	Whole Kiosk (for End user)	StaySafe+ Mask Detection/ Temp Screening Face Recognition (with Mask)

Timeline:

HSK-101: Kit for Kiosk Maker

(all items in the plate to integrated into Kiosk)

Available time: July-31-2020

HSK-200: complete Kiosk

(to mount on the wall/ Stand)

Available time: Sep-30-2020

Available SDK for customer eHR system for software integration

System Diagram



PoE LAN

W10IB3S-PCH2LB

- 4GB RAM
- 128 GB SSD
- Linux uBuntu 18.04
- Built-in Light bar
- Speaker

I/O

- Gb- LAN RJ-45 x 1
- PoE LAN (for Camera)
- 1x USB 3.0, 1x USB 2.0
- 1x COM

Optional:
RFID (for badge contactless)
WiFi (built-in front bezel)
DIDO (for Door Lock)



P3T6522E2-F

Dual Lens:

- 1080p CMOS imager
- Infrared Thermometer (16x 12 thermopile sensor array)
- 50-80cm face-temp measurement



**Winmate
StaySafe App**

AI Facial Recognition Engine

Temperature Measuring Camera VS Traditional Thermal Comparison Chart

Temperature Measuring Camera



Analogue Thermal



Screenshots from Actual Thermal Footage

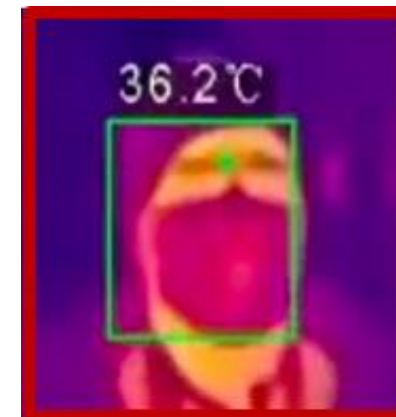

Medical Mask



Hot Drink non-detection

Price	Cost-effective	High
Live Video	Yes	-
False Alarm by Bringing Coffee	Face Detection Solution	Yes
Technology	IP Camera	Analogue
Photo Snapshot	Yes	-
Alarm & Automation	Digitalized Alarm	-
Remote Access	HTML	-
Privacy Concern	-	Physiological Characteristics

System Set-up

- System components are portable for easy relocation if the system needs to be moved.
- Monitors individuals from a distance of 50 ~ 80 cm away.
- Enables a fast assessment without personal contact.

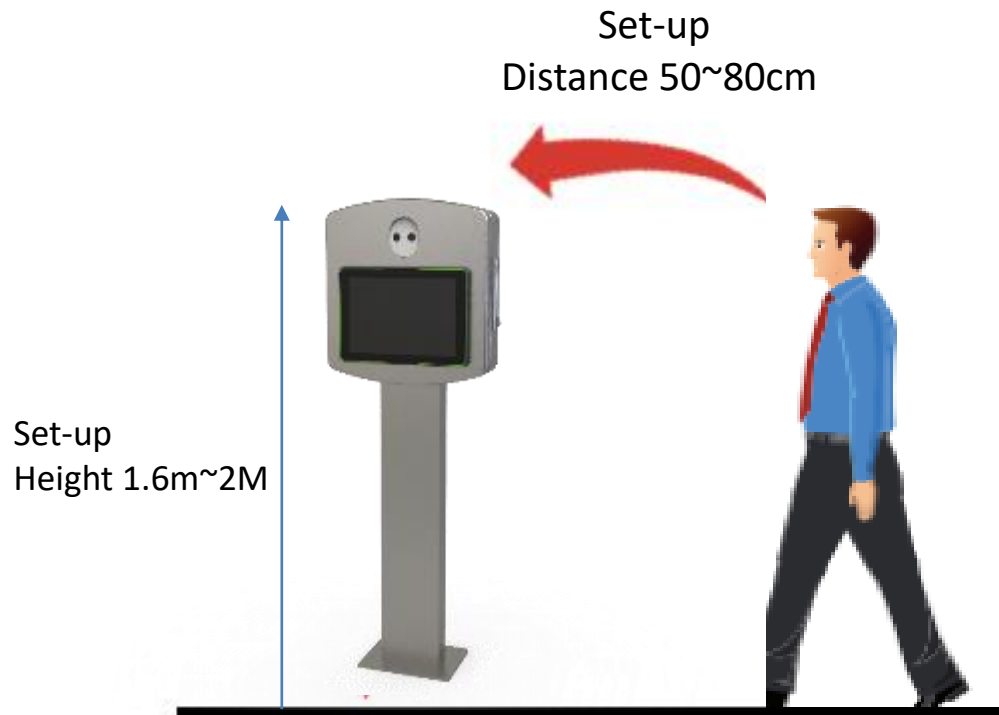

Application Scenario



School



Public Transportation



Office



Hospital



Factory



Retail

Avoid areas with interference

- Heaters
- Microwave ovens
- High-power lamps

Avoid deploying in areas

- Outdoors
- Direct sunlight or Backlight
- Reflective surfaces
- High ambient temperature
- Strong airflow

Whole Kiosk solution (All in one)

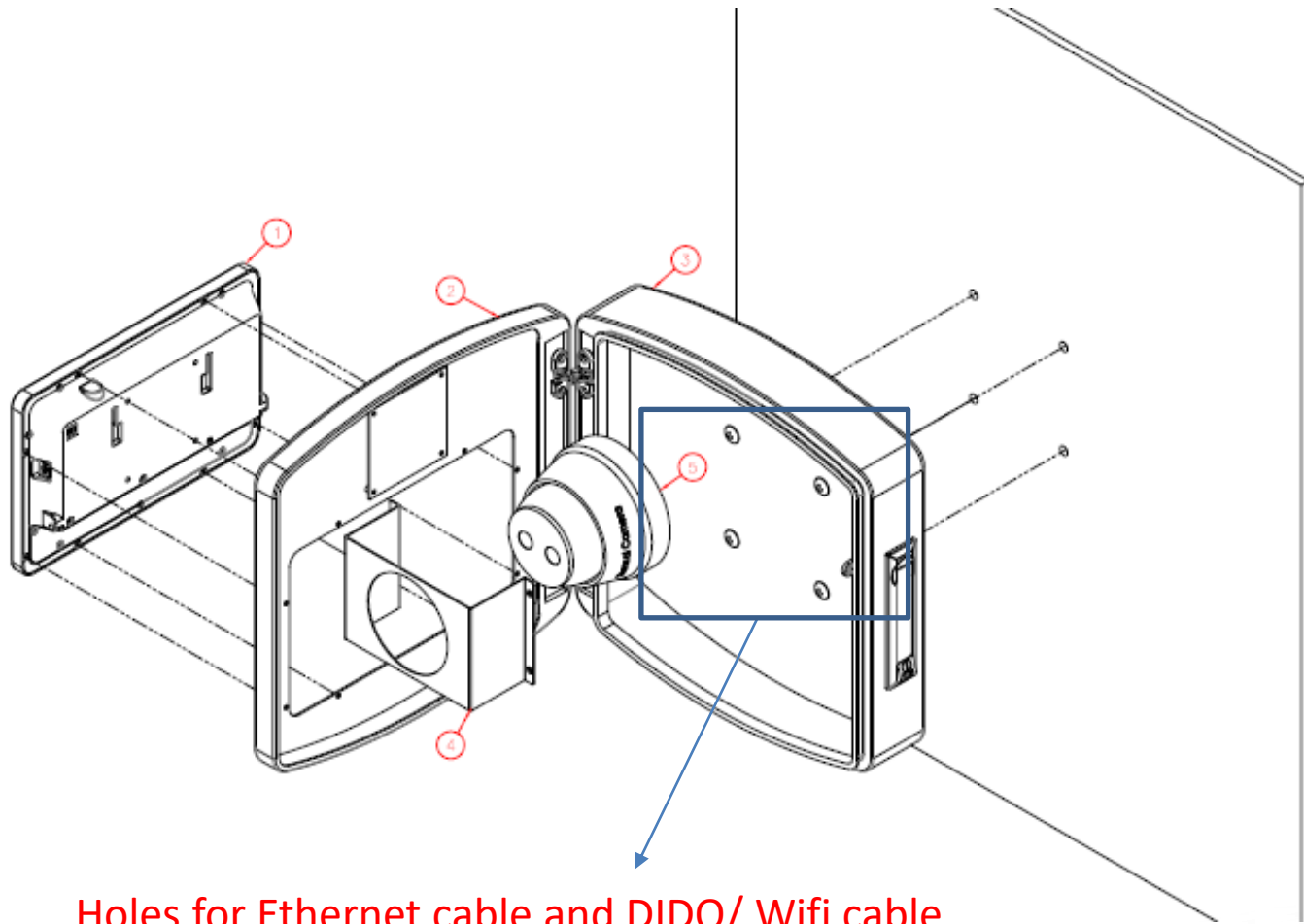

Holes for Ethernet cable and DIDO/ Wifi cable
Extra 4x holes for customer's accessories mounting



Bracket (Optional)



StaySafe App

The World's Top Cross-Platform
AI Facial Recognition Engine

Special Highlights of the system

Winmate StaySafe App

- Dual Camera for Facemask and face temp detection
- High accuracy and reliable detection rate
- Edge side calculation without upload to cloud (privacy issue)
- Facemask detection without facial recognition (privacy issue)
- Camera-end pre-process (IR Thermometer) and Intel Open VINO (facial detection) to lower the PC/ Graphic requirement



Touchless Biometric Recognition for a Post-Pandemic Era

Facial Recognition with Masks

Algorithm provides the ability to accurately recognize a person's identity, even if they are wearing a mask. It enables instantaneous and hygienic touchless biometric recognition



Advanced Image Pre-processing

Enhancement technology improves image quality in the pre-processing phase and increases accuracy by 11.65%.

*Images are taken in 550 Lux environment.

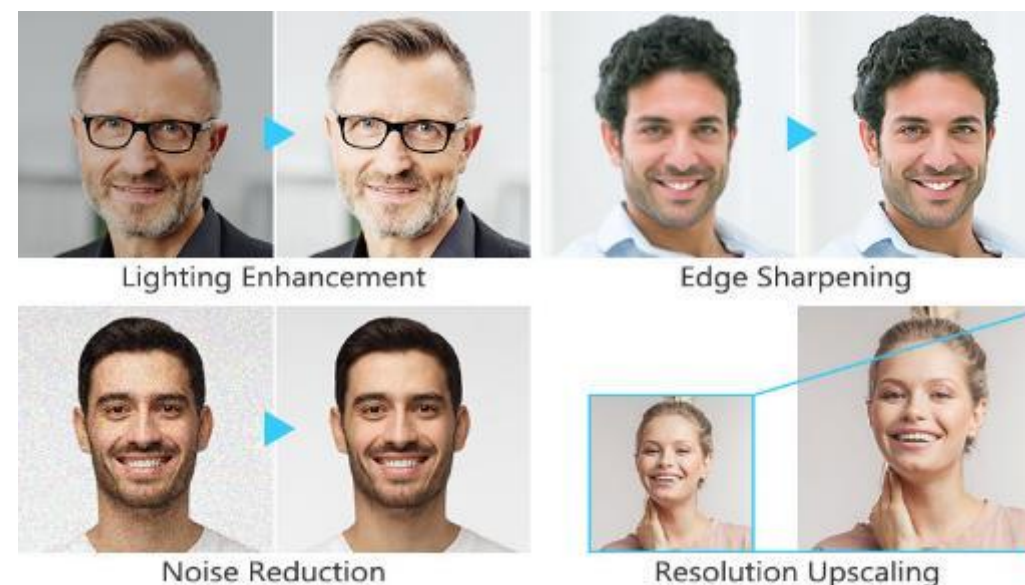

Standby mode/ Setting Menu



Need password

Trigger to move between standby mode and Kiosk mode

RFID: U_ID
Black list
White list

StaySafe App: Kiosk Mode— Passed Condition

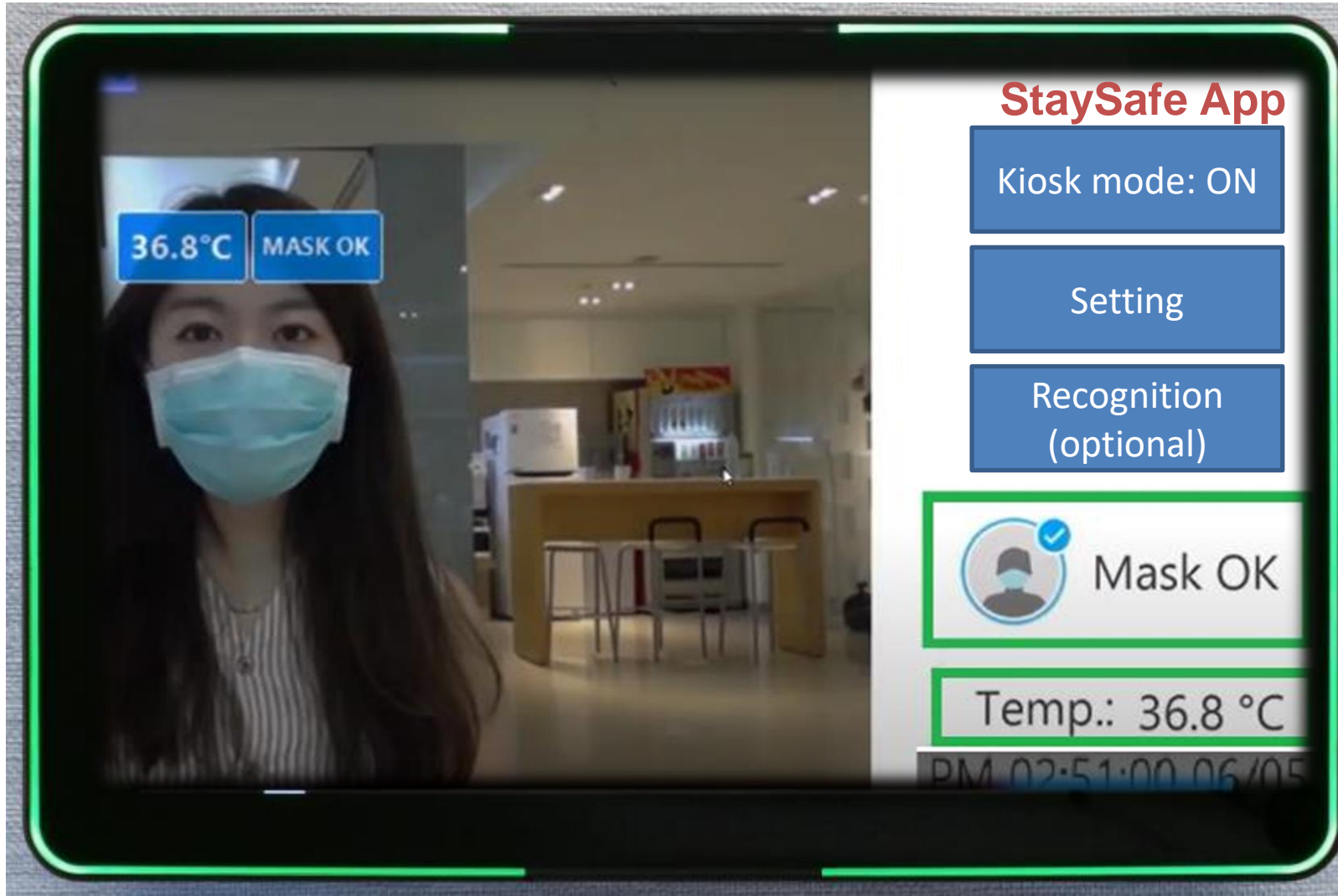

ON: Kiosk mode lock
Off: Need password



Need password



Mask Detection

Temperature Screening

Kiosk Mode with Recognition: Passed

Import RFID, Photos DB

Match with photos stored in local machine

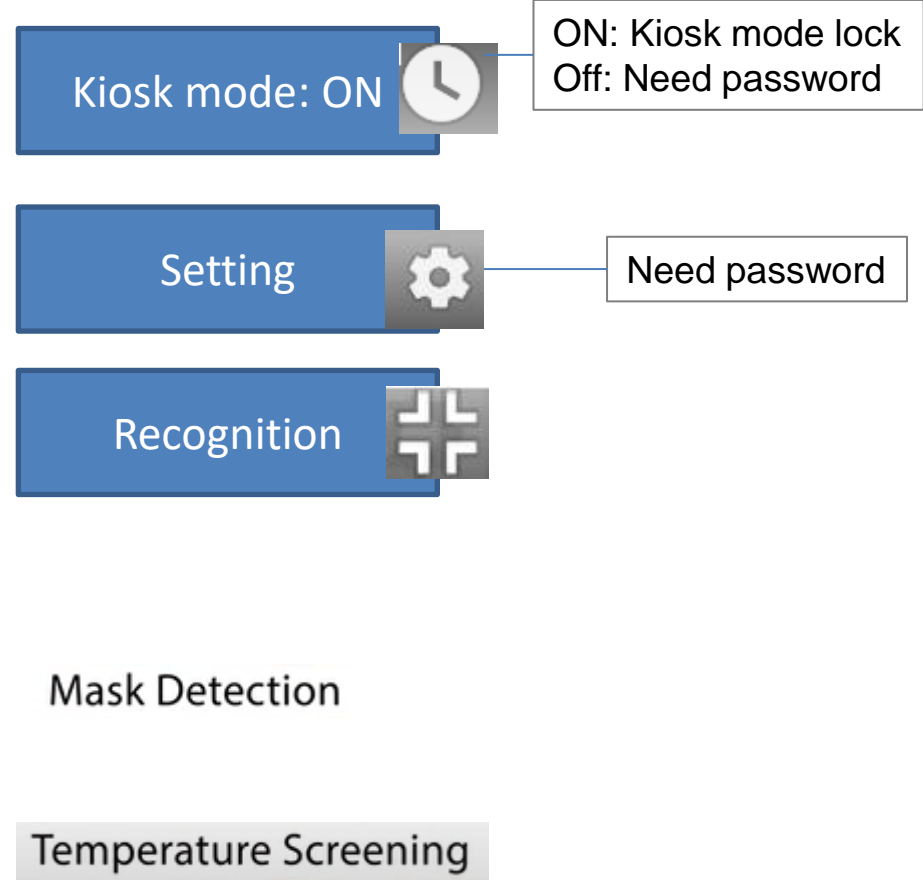
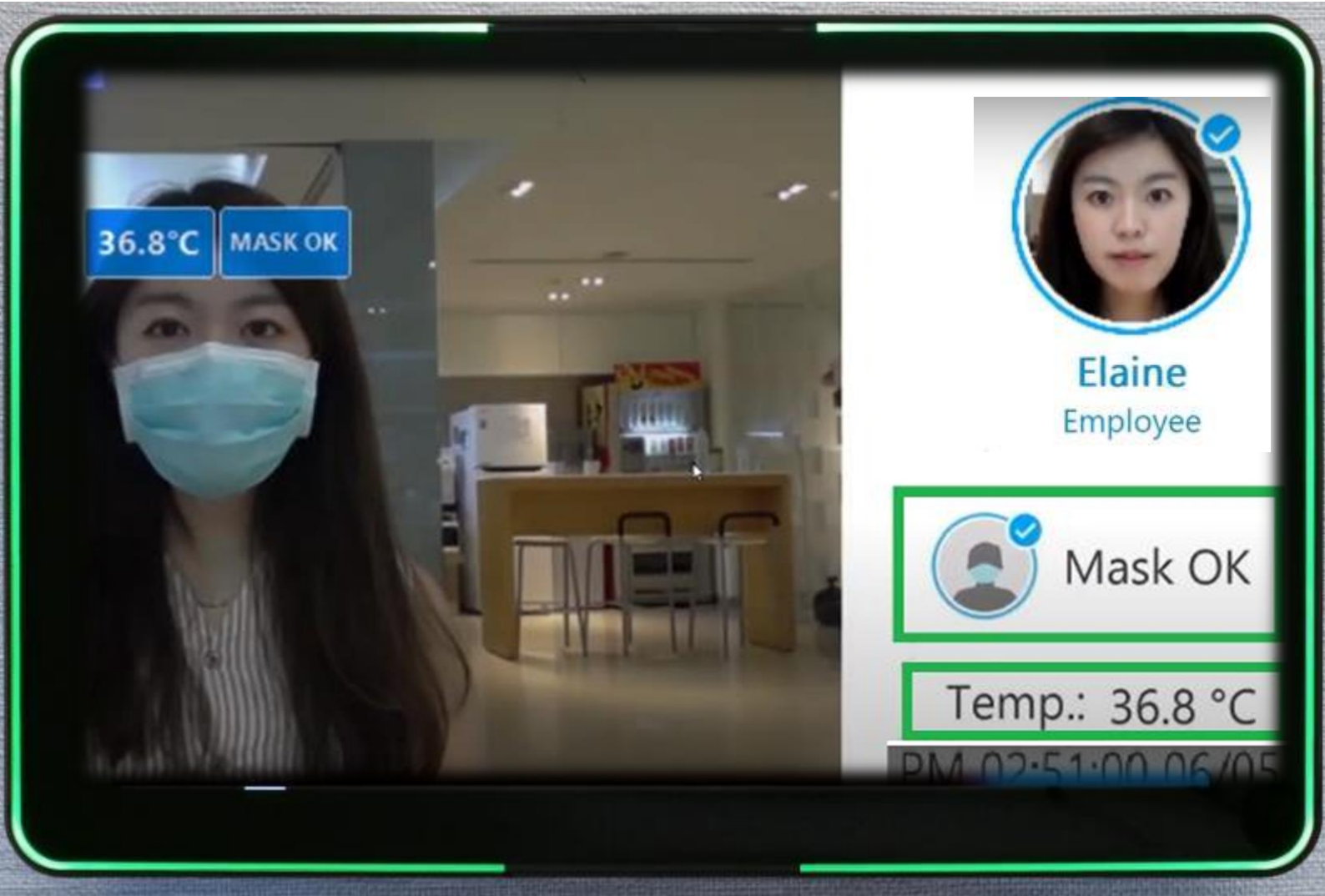

Kiosk Mode: Alert Condition

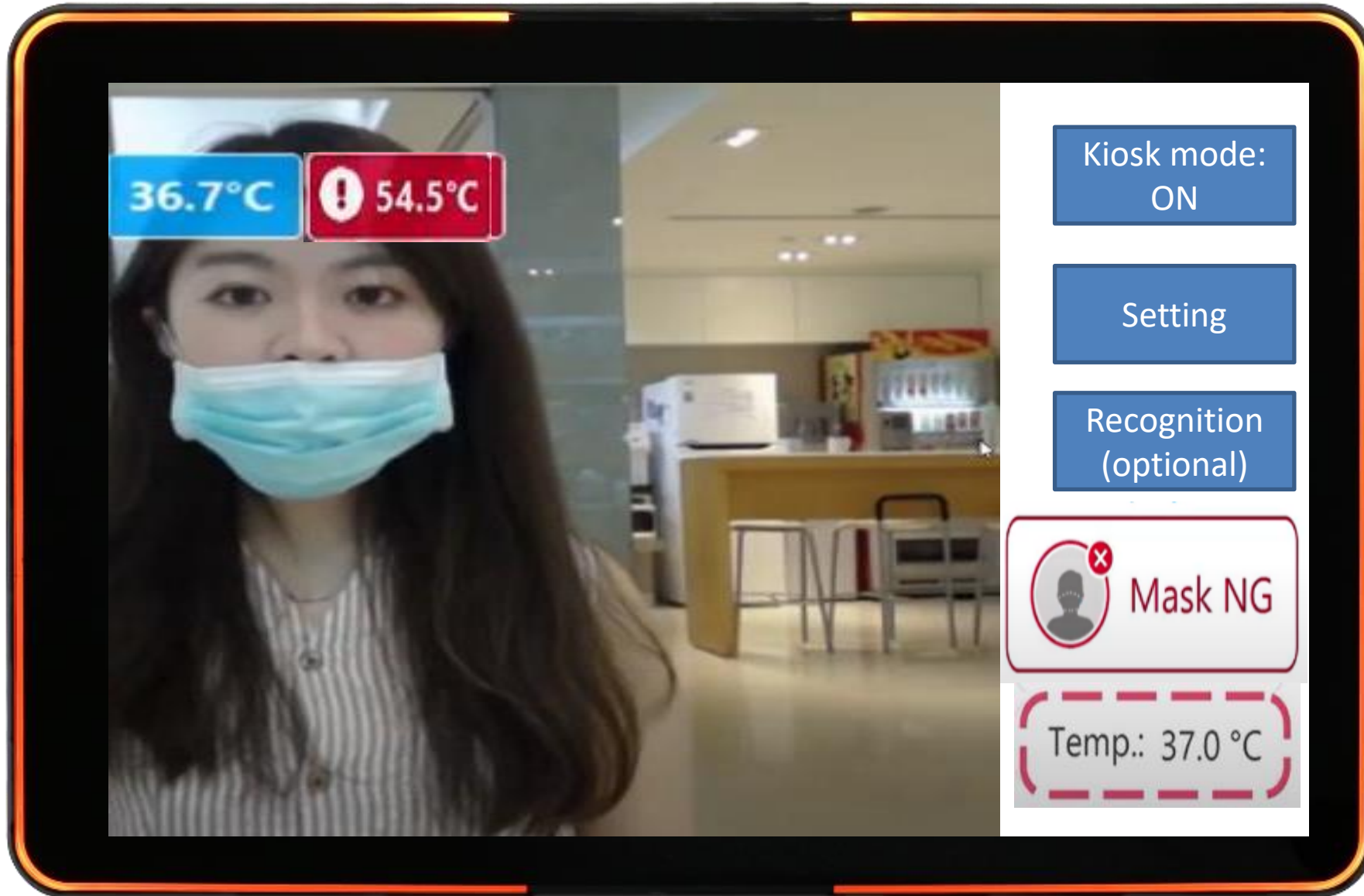

ON: Kiosk mode lock
Off: Need password



Need password

Mask Detection

Temperature Screening



Pioneering Smart Access Control Solutions

All-around LED
status light bar

Access Control Solution

Why Winmate?

Winate provides a wide range of human-machine interfaces (HMI) for access control applications in factory or building automation, machine control, point-of-information kiosks, hospitality.

Our HMI solutions include:

- The latest Android™, Windows® or Linux operating system
- Built-in HF RFID/ NFC
- LED Status Light Bar, optional web camera
- Durable design

Core Products

- S Series HMI Devices
- Multi-Touch Chassis Display



“BRIDGE THE GAP BETWEEN YOUR DIGITAL SYSTEM AND PHYSICAL WORKPLACE.”

Design Concept

- Building automation
- Growing demand for industrial grade and sleek HMI
- Focus application: access control

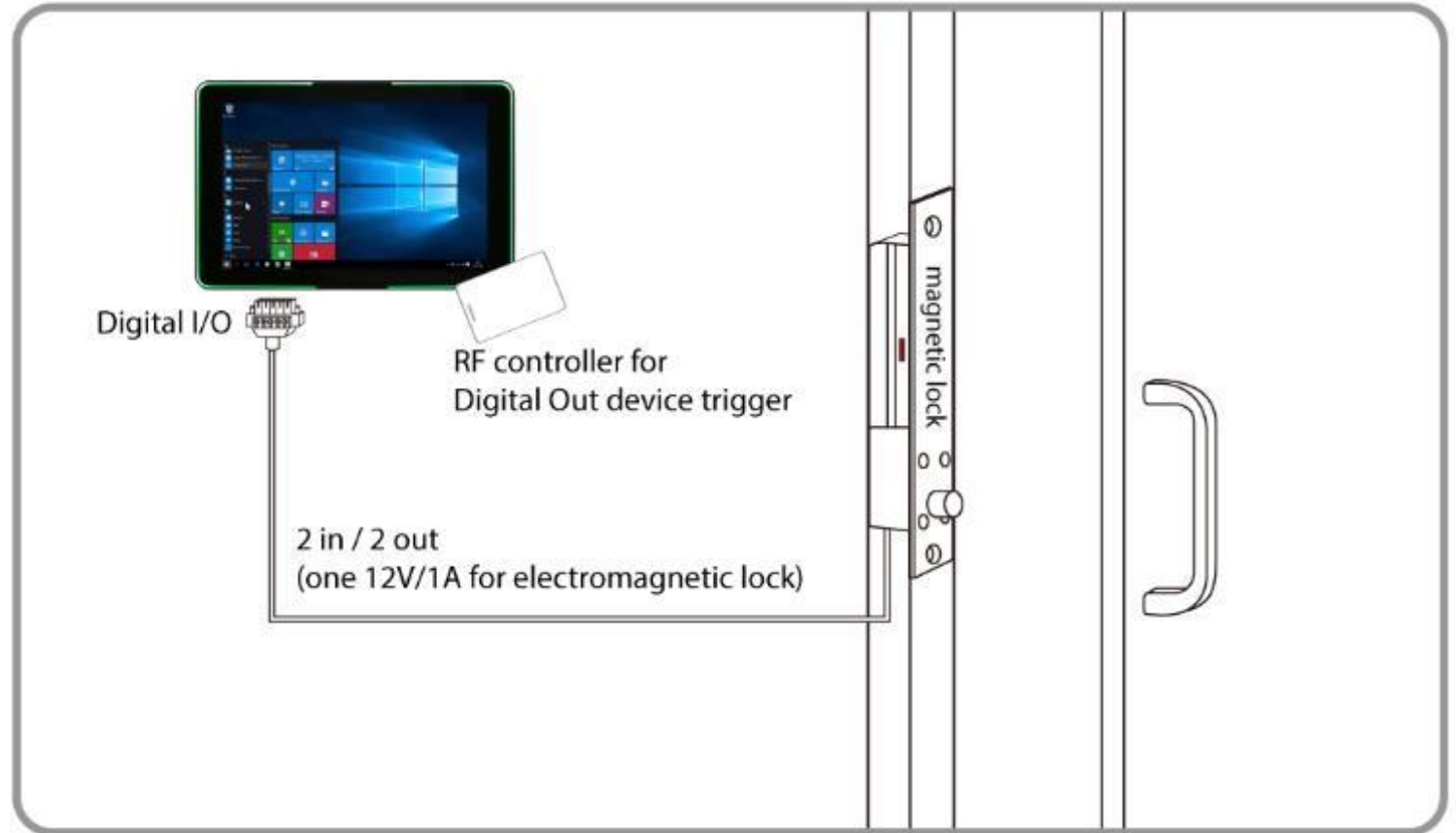

LED Status Indicators



Equal light intensity distribution,
high visibility and energy saving.

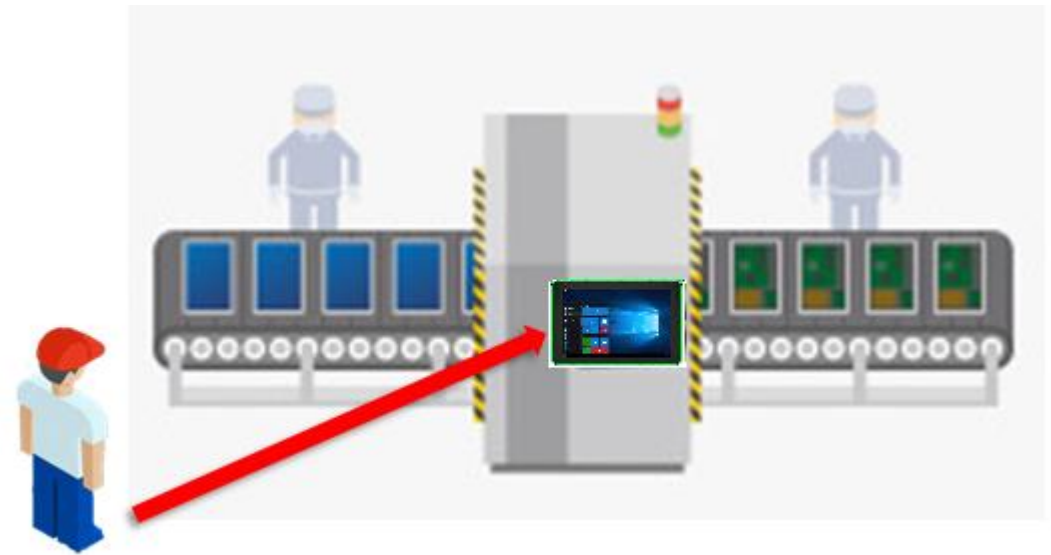

Windows



Android

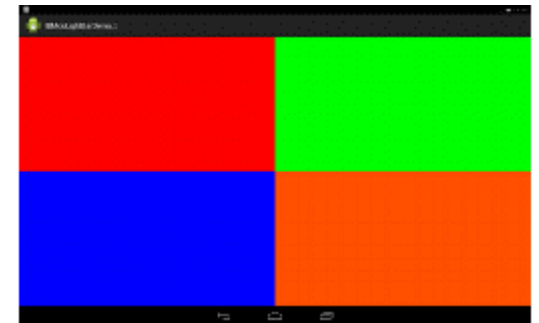

Built-in HF RFID/ NFC Reader



Limit access control to increase security.

Power over Ethernet (PoE)



Data and power transmission in a single cable for smooth integration.



Front IP65 Waterproof and Dustproof



Protected against damages from outer dust and water splash from the front side.

x86 S Series HMI

7"/ 10.1"/ 15"

- Intel® Celeron® Bay Trail-M N2930, 1.83 GHz



X86 S Series HMI Features

Powerful Computing System

- Intel® Celeron® Bay Trail-M N2930, 1.83 GHz
- 2 GB DDR3L 1600 SODIMM (Optional 8 GB)
- 64 GB M.2 SSD
- Windows 10 IoT Enterprise, Windows Embedded 8.1 Industry Pro, Windows Embedded 7 Standard

Brilliant Display

- 10.1" TFT LCD with PCAP touch

Peripherals & Data Capture

- LED status light bar (Optional)
- 2MP webcam (Optional)
- HF RFID reader (Optional)

Audio

- 1 x 1 Watt Speaker

External Connectivity

- 1 x USB 3.0, 1 x USB 2.0
- 1 x RJ 45-10/100/1000 Mbps (LAN)
- 1 x RJ 45(PoE)
- 1 x RS-232/422/485

Rugged Design

- Front IP65 waterproof and dustproof



Custom configuration



Memory



LED Status Light Bar



HF RFID Reader



2MP Webcam

Contato
customer.salud@tempelgroup.com
www.tempelgroup.pt

Tempel Group no mundo

BARCELONA · MADRID · VALENCIA · BILBAO · SEVILHA · LISBOA · PORTO · BUENOS AIRES · LIMA
SANTIAGO DE CHILE · BOGOTÁ · SÃO PAULO · CIDADE DE MÉXICO · CIDADE DE PANAMÁ · MONTEVIDEO · QUITO



 **tempel**
group